

VARIO TB-PA

DIN EN 50216-5:2002 + A3:2006

DIN42567C-G34i
DIN42567C-G12i
DIN42567C-G1i



TB 310-PA

TB 330-PA

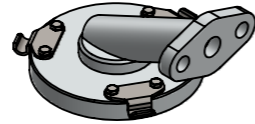

DIN42567A

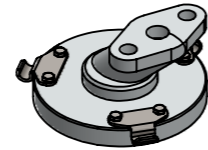

DIN42567B

DIN42562

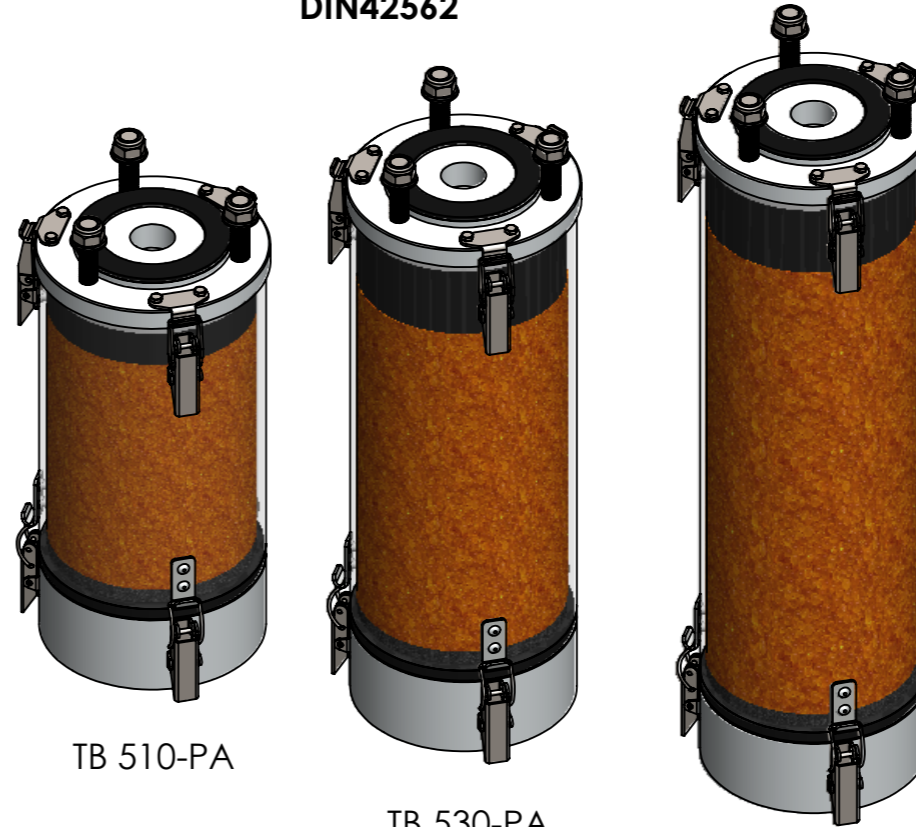

TB 510-PA

TB 530-PA

TB 560-PA

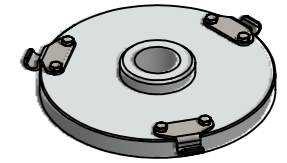

DIN42567C-G34i
DIN42567C-G1i

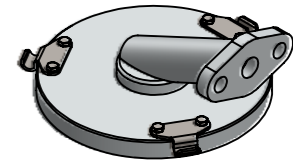

DIN42567A

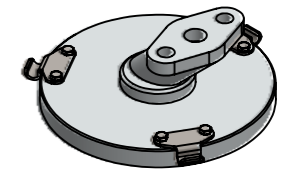

DIN42567B

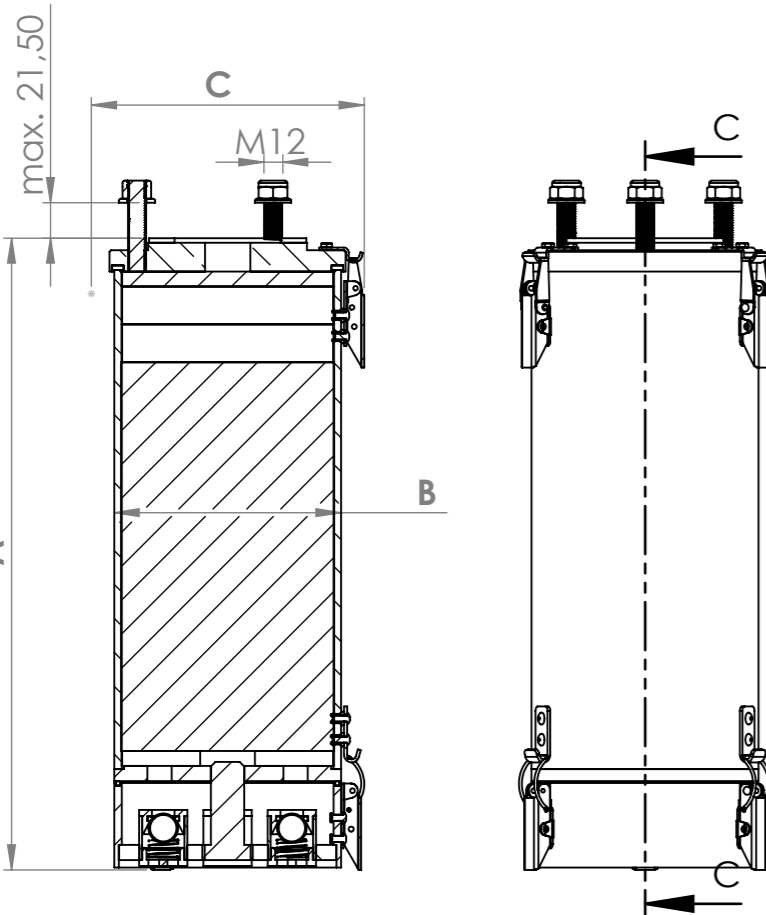

Adsorber	Article no. Artikel Nr.	Code / Typenschlüssel	Total weight Gewicht [kg]	Adsorbents weight Gewicht [kg]	A [mm]	B [mm]	C [mm]	Connection Anschluss
VARIO TB 310-PA	06.0005.19	DV TB 310-PA_N_11_V2_SA_DIN42567C-G12i	3,0	1,1	285	110	150	DIN 42567 C G 1/2" F.
	06.0005.25	DV TB 310-PA_N_11_V2_SA_DIN42567C-G34i	2,9	1,1	285	110	150	DIN 42567 C G 3/4" F.
	06.0005.17	DV TB 310-PA_N_11_V2_SA_DIN42567C-G1i	2,9	1,1	285	110	150	DIN 42567 C G 1" F.
VARIO TB 330-PA	06.0005.22	DV TB 310-PA_N_11_V2_SA_DIN42567A	3,1	1,1	285	110	150	DIN 42567 A
	06.0005.23	DV TB 310-PA_N_11_V2_SA_DIN42567B	3,1	1,1	285	110	150	DIN 42567 B
	06.0010.18	DV TB 330-PA_N_11_V2_SA_DIN42567C-G12i	3,8	1,8	385	110	150	DIN 42567 C G 1/2" F.
VARIO TB 510-PA	06.0010.24	DV TB 330-PA_N_11_V2_SA_DIN42567C-G34i	3,7	1,8	385	110	150	DIN 42567 C G 3/4" F.
	06.0010.25	DV TB 330-PA_N_11_V2_SA_DIN42567C-G1i	3,7	1,8	385	110	150	DIN 42567 C G 1" F.
	06.0010.20	DV TB 330-PA_N_11_V2_SA_DIN42567A	3,9	1,8	385	110	150	DIN 42567 A
VARIO TB 530-PA	06.0015.19	DV TB 510-PA_N_22_V2_SA_DIN42562	5,6	2,5	320	150	190	DIN 42562
	06.0015.20	DV TB 510-PA_N_22_V2_SA_DIN42567A	5,5	2,5	320	150	190	DIN 42567 A
	06.0015.21	DV TB 510-PA_N_22_V2_SA_DIN42567B	5,5	2,5	320	150	190	DIN 42567 B
VARIO TB 560-PA	06.0015.23	DV TB 510-PA_N_22_V2_SA_DIN42567C-G34i	5,4	2,5	320	150	190	DIN 42567 C G 3/4" F.
	06.0015.26	DV TB 510-PA_N_22_V2_SA_DIN42567C-G1i	5,3	2,5	320	150	190	DIN 42567 C G 1" F.
	06.0020.19	DV TB 530-PA_N_22_V2_SA_DIN42562	7,1	3,7	420	150	190	DIN 42562
VARIO TB 530-PA	06.0020.28	DV TB 530-PA_N_22_V2_SA_DIN42567C-G34i	6,9	3,7	420	150	190	DIN 42567 C G 3/4" F.
	06.0020.29	DV TB 530-PA_N_22_V2_SA_DIN42567C-G1i	6,8	3,7	420	150	190	DIN 42567 C G 1" F.
VARIO TB 560-PA	06.0030.19	DV TB 560-PA_N_22_V2_SA_DIN42562	8,6	5,0	520	150	190	DIN 42562

All seals/Dichtungen:
NBR



Allgemein-
toleranzen
DIN ISO 2768-mK



Rohabmessung:

Material:

Gewicht (kg):

Benennung:

VARIO TB-PA
Overview / Übersicht

Artikelnummer:

Status freigegeben	Format A3
Maßstab	Blatt / von

Identnummer:

1:5
1 / 1

Rev Änderung

Datum

Name

Schutzvermerk ISO 16016 beachten